

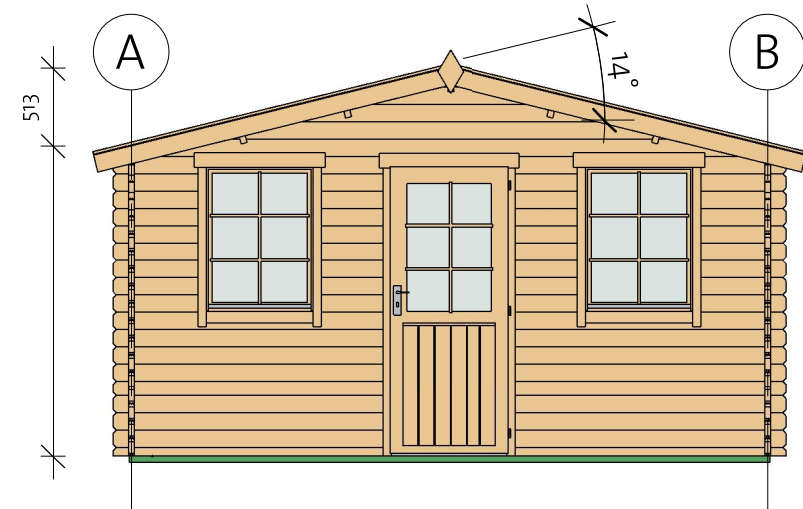

Kiel (425x380)

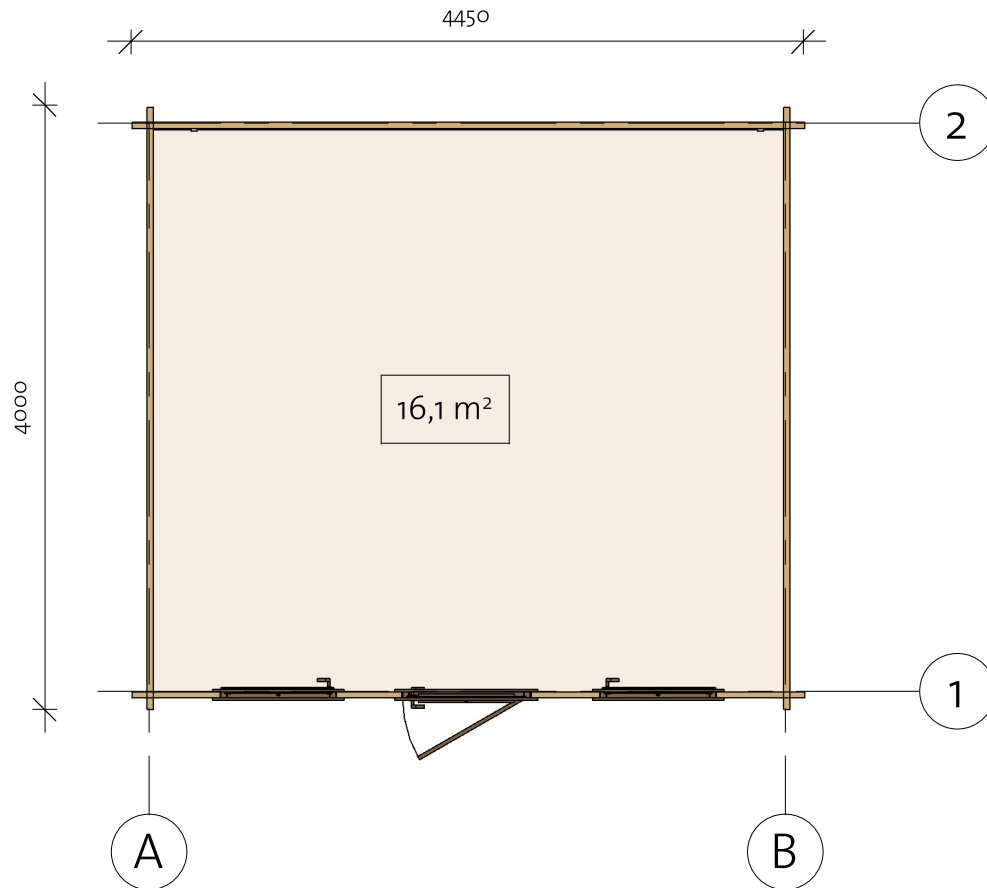

Kiel (425x380)

Foundation

Impregnated foundation beams				
Mark	Type	Profile	Count	Length
IFB	IFB 70x40		8	4240

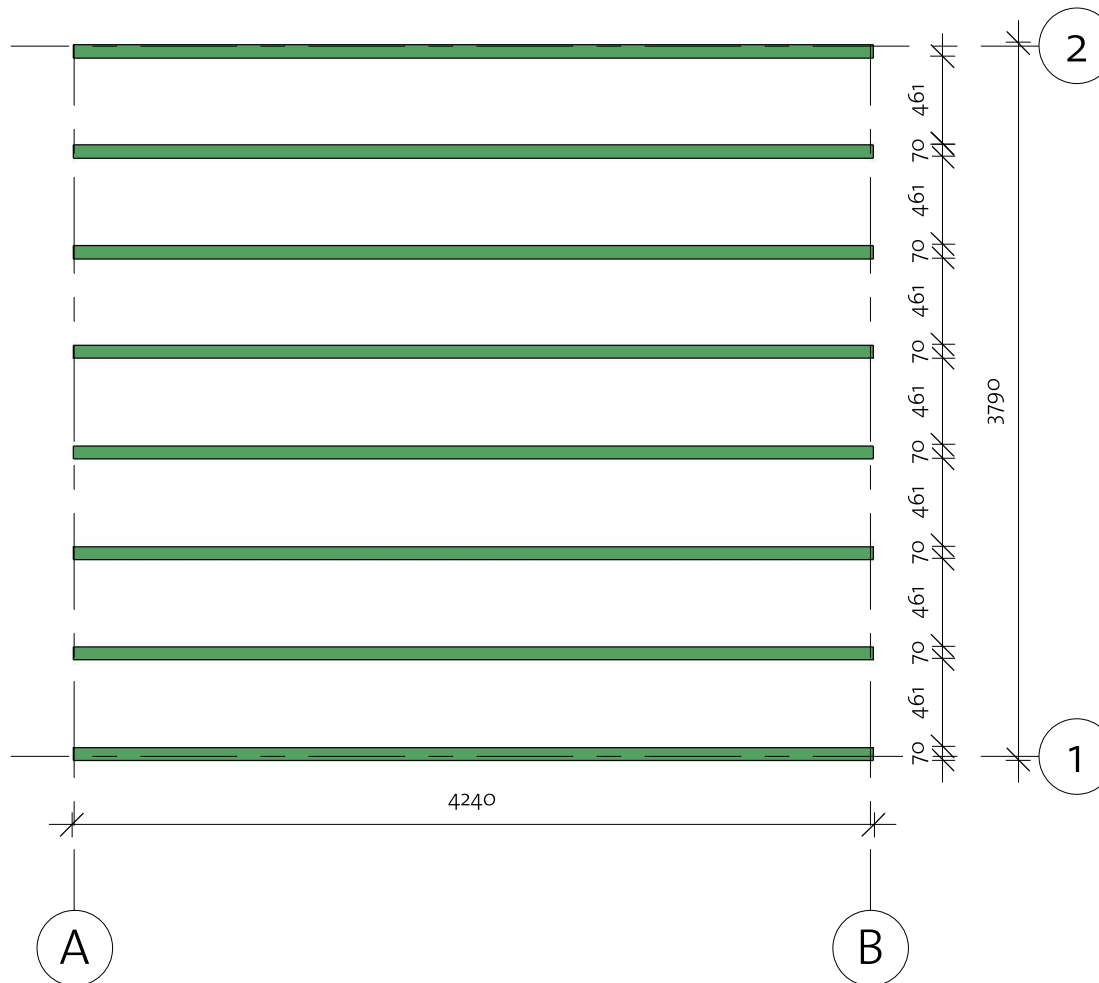



Kiel (425x380)

Floor Plan

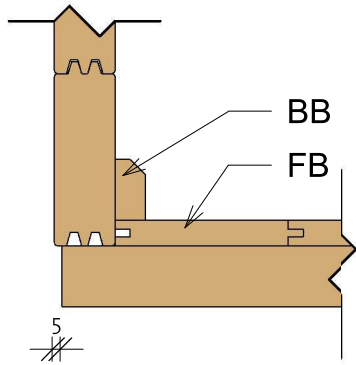
I Baseboard



Floor Schedule

Mark	Type	Profile	Count	Length
FB	FB 17x114		38	3714
BB1	BB 20x40		2	3800
BB2	BB 20x40		2	4250

92001062_200207

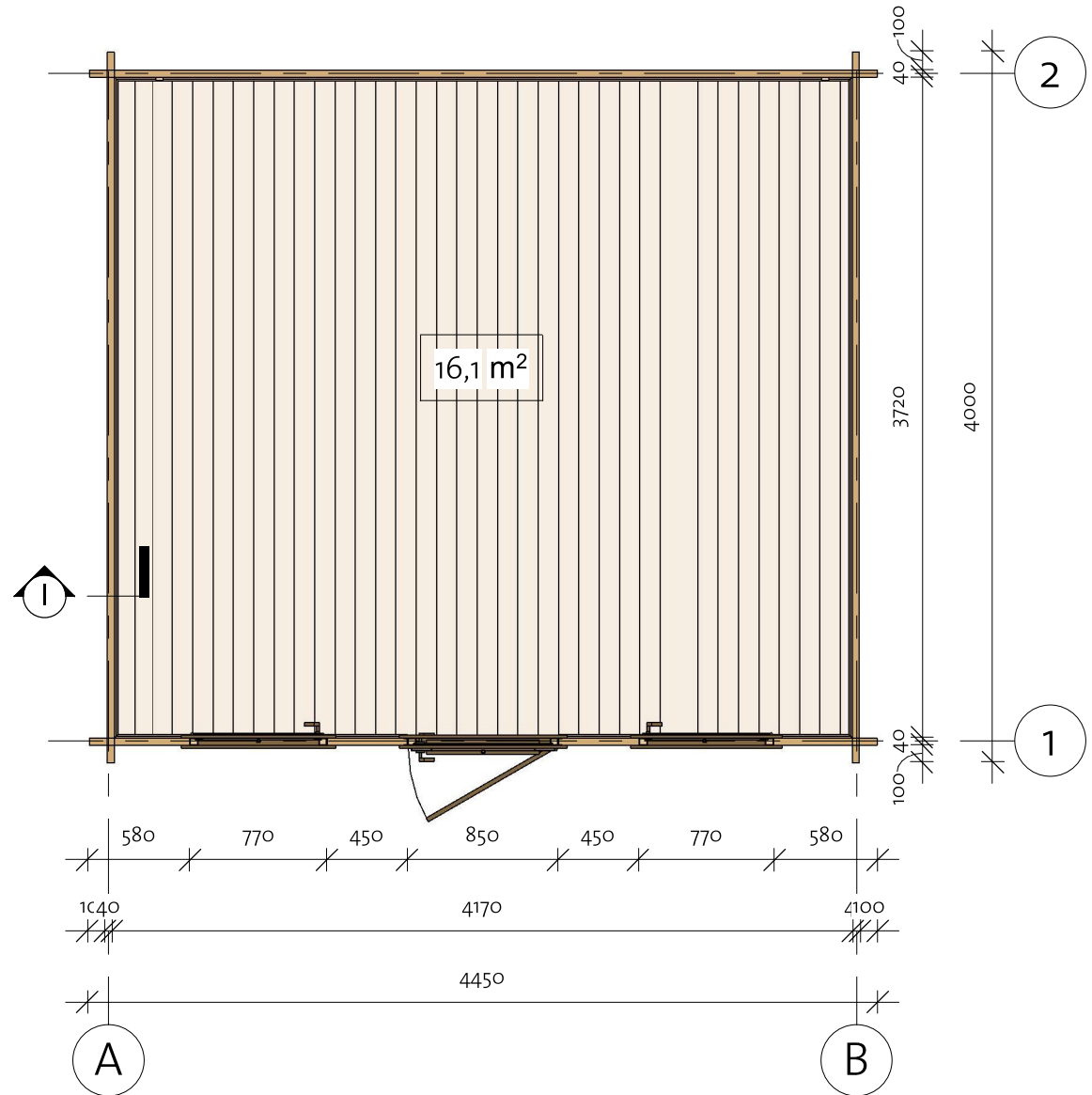

Kiel (425x380)

Wall 1

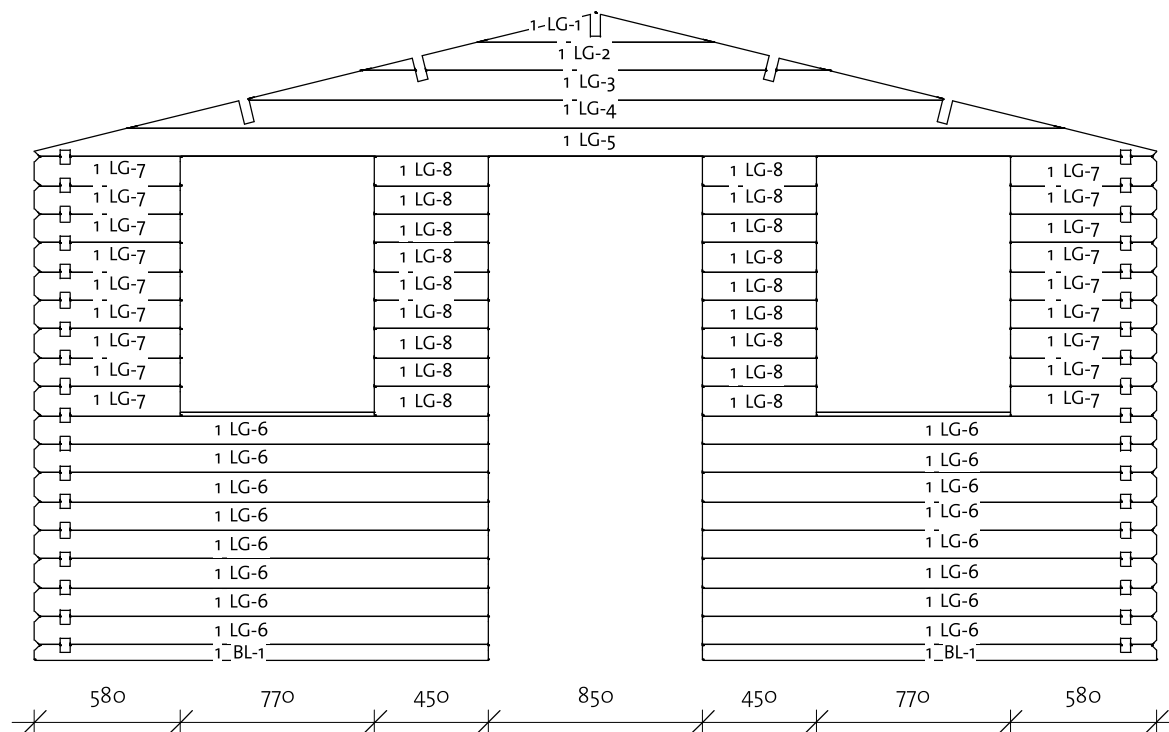
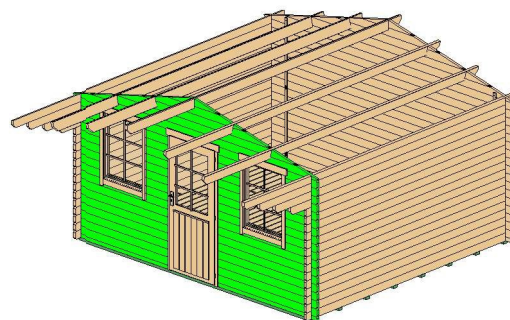

Wall 1			
Mark	Profile	Count	Cut Length

1BL-1	40x57	2	1800
1LG-1*	40x114	1	927
1LG-2*	40x114	1	1854
1LG-3*	40x114	1	2755
1LG-4*	40x114	1	3707
1LG-5*	40x114	1	4450
1LG-6	40x114	16	1800
1LG-7	40x114	18	580
1LG-8	40x114	18	450

* Gable - delivered premounted

Log Profile Wall 1	
Profile	Profile

40x57	
40x114	

Kiel (425x380)

Wall 2

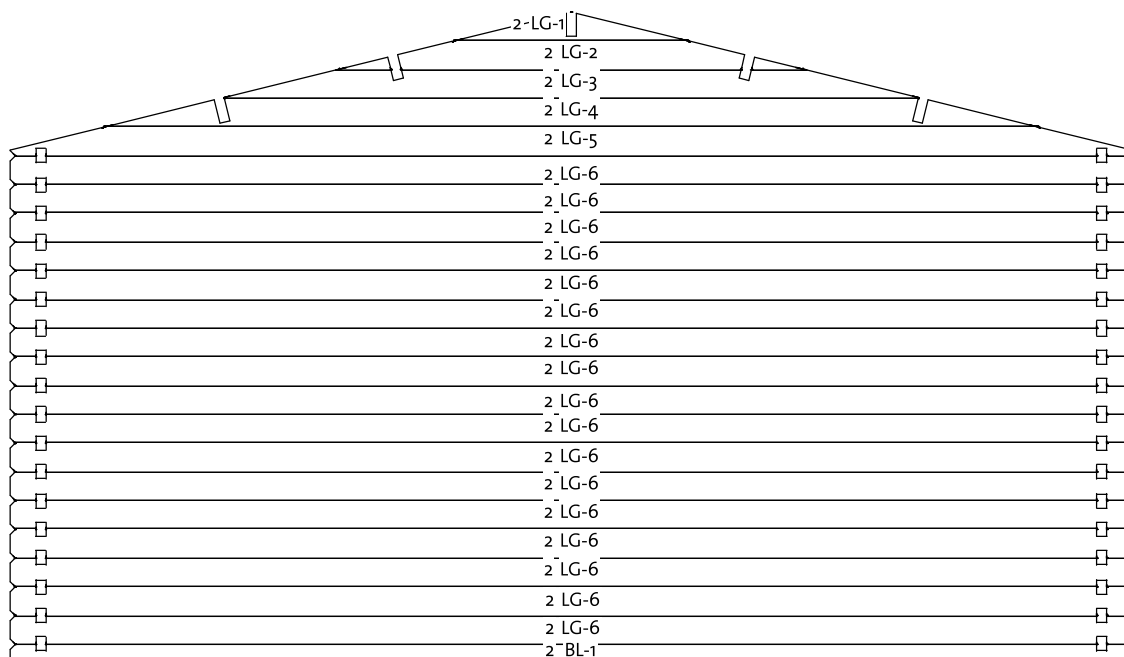
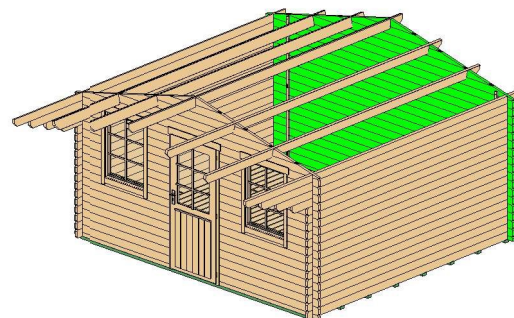



Wall 2			
Mark	Profile	Count	Cut Length

2BL-1	40x57	1	4450
2LG-1*	40x114	1	927
2LG-2*	40x114	1	1854
2LG-3*	40x114	1	2755
2LG-4*	40x114	1	3707
2LG-5*	40x114	1	4450
2LG-6	40x114	17	4450

* Gable - delivered premounted

Log Profile Wall 2	
Profile	Profile

40x57	
40x114	

Kiel (425x380)

Wall A

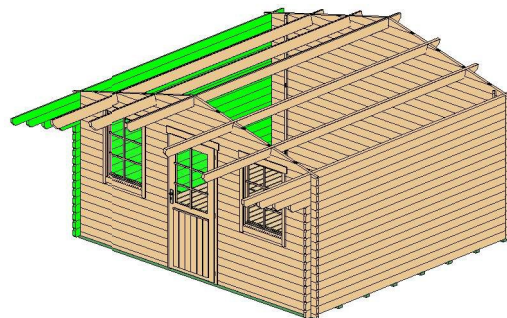

Wall A			
Mark	Profile	Count	Cut Length

ALG-1	40x114	14	4000
ALG-2	40x114	1	4300
ALG-3	40x114	1	4600
ALG-4	40x114	1	4900
ATL-1	40x114	1	5300

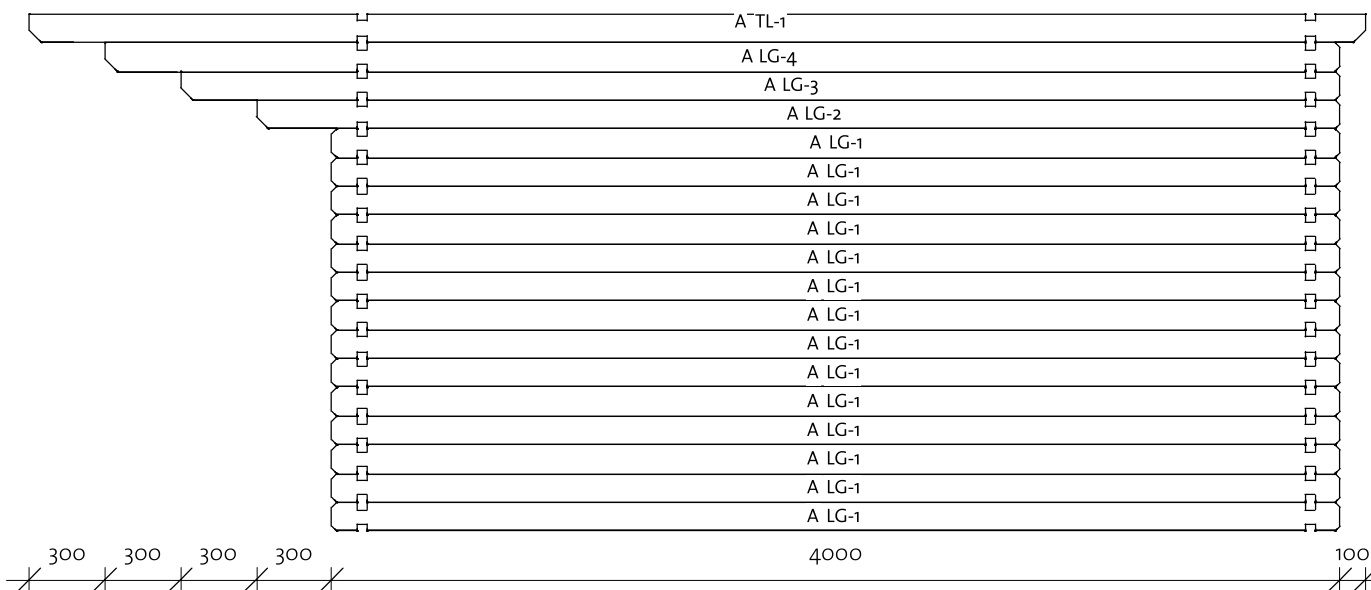

Log Profile Wall A	
Profile	Profile

40X114	
40X114	

Kiel (425x380)

Wall B

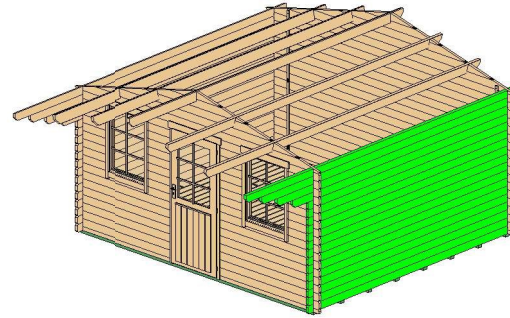

Wall B			
Mark	Profile	Count	Cut Length

BLG-1	40x114	14	4000
BLG-2	40x114	1	4300
BLG-3	40x114	1	4600
BLG-4	40x114	1	4900
BTL-1	40x114	1	5300

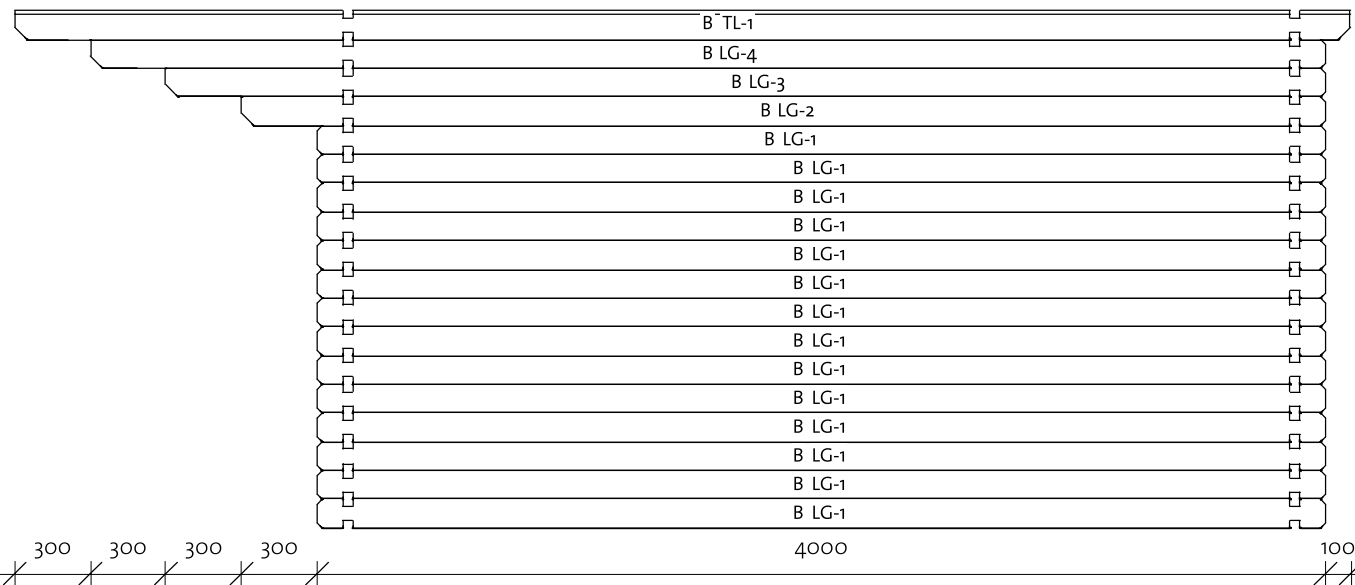





Log Profile Wall B	
Profile	Profile

40x114	
40x114	

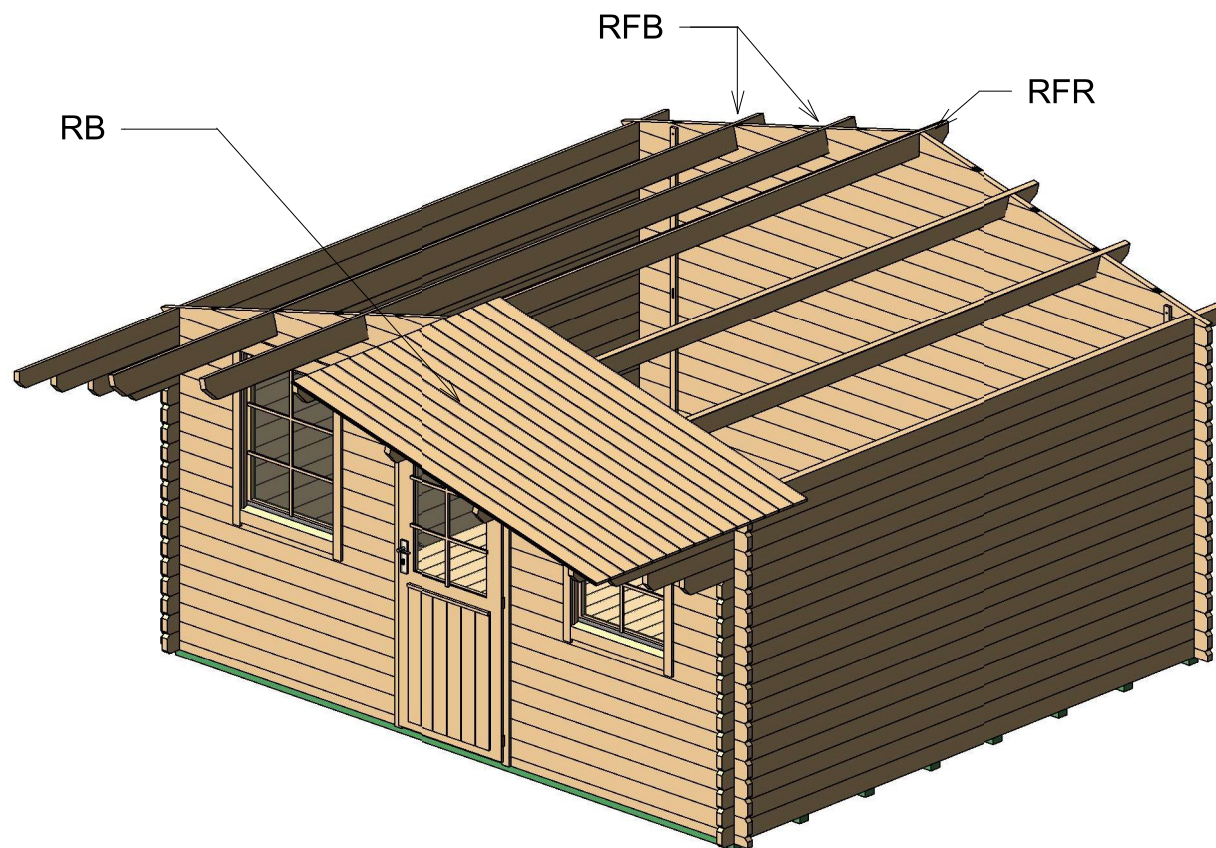
Kiel (425x380)

Roof 1



Roof				
Mark	Type	Profile	Count	Length
RFR	Ridge 40x143		1	5300
RFB	Beam 40x143		4	5300
RB	17x114		96	2390

Kiel (425x380)

Roof 2

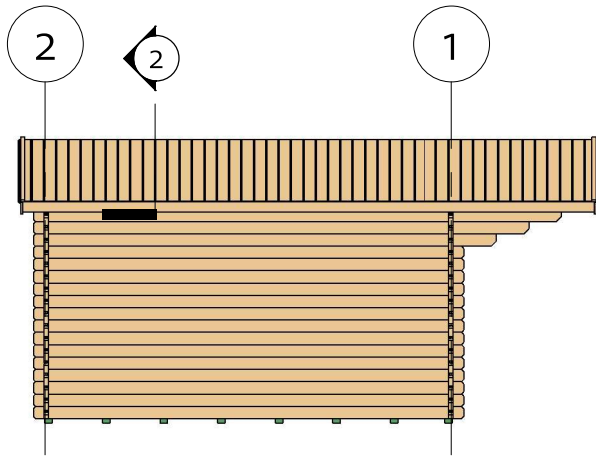

② Fascia

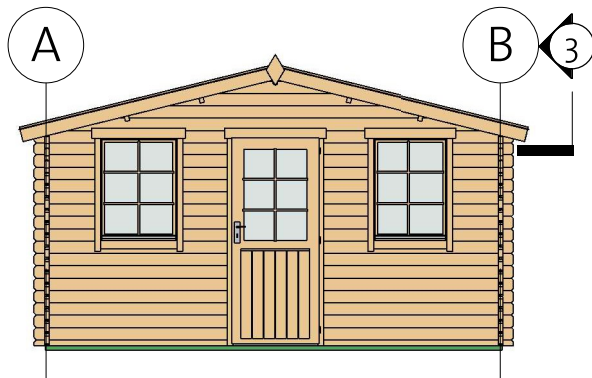
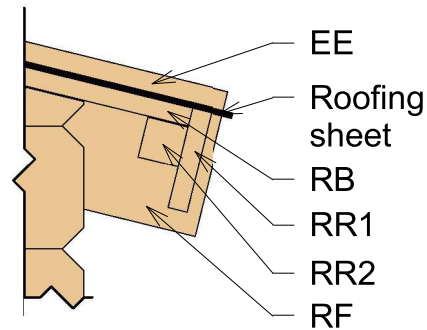

③ Roof Reinforcement

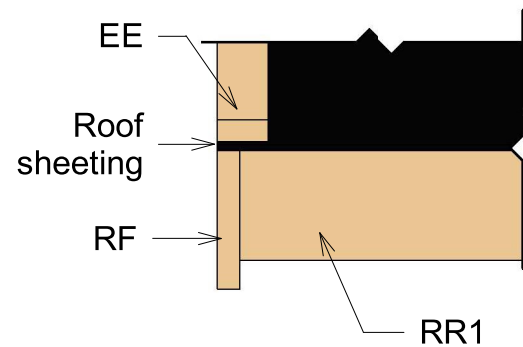













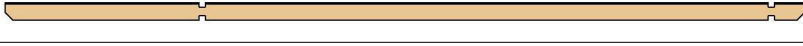

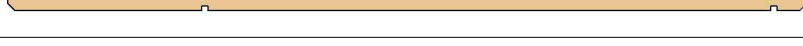



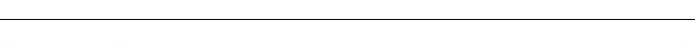
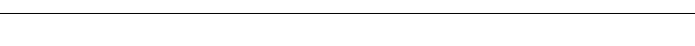
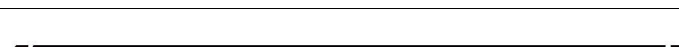



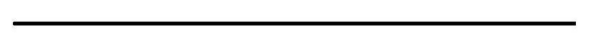

Fascia Schedule

Mark	Type	Profile	Count	Length
EE	Eave Edging 18x40		4	2425
RF	Roof Fascia 18x120		4	2425
RR1	Roof reinforcement 18x95		2	5300
RR2	Roof reinforcement 38x38		2	5300

Kiel (425x380)

List of all items 1

	RFB	Beam 40X143			4	5300
	RFR	Ridge 40X143			1	5300
A	TL-1	Log 40X114			1	5300
B	TL-1	Log 40X114			1	5300
A	LG-4	Log 40X114			1	4900
B	LG-4	Log 40X114			1	4900
A	LG-3	Log 40X114			1	4600
B	LG-3	Log 40X114			1	4600
2	BL-1	Log 40X57			1	4450
2	LG-6	Log 40X114			17	4450
A	LG-2	Log 40X114			1	4300
B	LG-2	Log 40X114			1	4300
	IFB	IFB 70X40			8	4240
A	LG-1	Log 40X114			14	4000
B	LG-1	Log 40X114			14	4000
	FB	FB 17X114			38	3714
	RB	17X114			96	2390
1	BL-1	Log 40X57			2	1800
1	LG-6	Log 40X114			16	1800
1	LG-7	Log 40X114			18	580
1	LG-8	Log 40X114			18	450

Kiel (425x380)



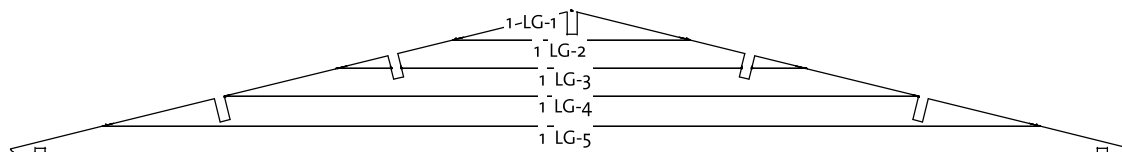

List of all items 2

① Gable 1

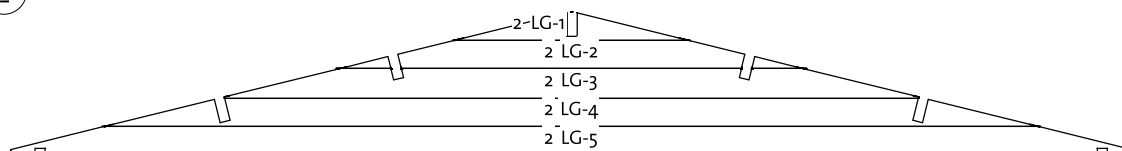







② Gable 2

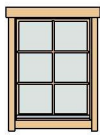

RR1	Roof reinforcement 18x95		2	5300
RR2	Roof reinforcement 38x38		2	5300
EE	Eave Edging 18x40		4	2425
RF	Roof Fascia 18x120		4	2425
Windboard 18x40			4	2200

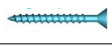
Romb 2 

CD4R	Classic door 4 right	840	1955	1	
DCB6	Door Crossbar 6	--	--	1	
CW1L	Classic window 1 left	765	990	1	
CW1R	Classic window 1 right	765	990	1	
WCB6	Windows Crossbar 6	--	--	2	

Hitblock	300-400 mm		
Bolts	M8 x 70		12
Screws	5,0 x 70		17
Nails	1,4 x 40		35
Screws	6,0 x 140		45
Screws	4,0 x 40		95
Screws	4,0 x 50		750